

WIFI

Three Phase Smart Meter

USER MANUAL

Ver.003006

1. General Description

WIFI type multi-function smart energy meter is designed to measure three phase four wire AC active energy and variable parameter. The meter have WIFI communication, it can use APP for remote reading and control on/off. All of its functions comply with the relative technical requirement for class 1 three phase watt hour meter in IEC62053-21 and its data communication rules obey the requirement WIFI 802.11b/g/n. It is a long life meter with the advantage of high stability , high over load capability , low power loss and small volume .

The meter should be installed in suitable environment with ambient temperature range between $-25^{\circ}\text{C} \sim +55^{\circ}\text{C}$, the relative humidity less than 75% and temperature limits between and $-40^{\circ}\text{C} \sim +70^{\circ}\text{C}$.

The meter is manufactured complying with international standard IEC62052-11 on “ Electricity metering equipment (AC) General requirements tests and test conditions ” and IEC62053-21 on “ Static meters for active energy (classes 1 and 2) ” .

2. Specification and Technical Parameters

2.1 Specification

Meter type	WIFI
Rate frequency	50 or 60 Hz
Rated current	1.5(6)A, 5A/CT, 5(60)A ,10(80)A
Rate voltage	3x120/208V , 3x220/380V , 3x230/400V , 3x240/415V
Normal voltage range	90%Un ~ 110%Un
Limits voltage range	70%Un ~ 120%Un
kWh Accuracy	Class 1
R.M.S accuracy	Class 0.5
Pulse constant	See meter
WIFI	802.11b/g/n ,only support 2.4GHz network , not support 5GHz network

2.2 Technical Parameters

2.2.1 Basic tolerance

Load Current		Power factor(COS ϕ)	Basic error(%)
Direct connection	CT connection		
$0.05I_b \leq I < 0.1I_b$	$0.02I_b \leq I < 0.05I_b$	1.0	1.0
$0.1I_b \leq I \leq I_{max}$	$0.05I_b \leq I \leq I_{max}$	1.0	1.0
$0.1I_b \leq I < 0.2I_b$	$0.05I_b \leq I < 0.1I_b$	0.5(L) 0.8(C)	0.5(L) 0.8(C)
$0.2I_b \leq I \leq I_{max}$	$0.1I_b \leq I \leq I_{max}$	0.5(L) 0.8(C)	0.5(L) 0.8(C)

2.2.2 Self-consumption

Current circuit is less than 1.5VA / each phase

Voltage circuit is less than 2W/8VA each phase

2.2.3 Starting current

Under the rated voltage , rated frequency and COS $\Phi = 1$, the meter shall start and continu

to register on application of 0.2% I_n (if CT is used) or 0.4% I_b.

2.2.4 Anti-creeping

The meter has anti-creeping logical circuit. When 115%U_n is connected to the meter and current circuit is cut, the meter shall not create more than one pulse in a stipulated time

2.2.5 Average-life

The meter can be used for at least 10 years in normal operation specified in this manual

2.2.6 LCD: 6+2 (999999.99kWh)

3. Basic Features

- 3.1 Measuring positive & negative active energy with negative energy accumulated into positive energy.
- 3.2 The meter also display three phase real voltage, real current, real active power, real reactive power, real power factor, real frequency
- 3.3 Pulse LED indicates working of meter, Pulse output with optical coupling isolation
- 3.4 it can use APP software for data reading and remoter control on/off.
- 3.5 display step by step with button
- 3.6 it has timing control function, it can set value from APP

4. Working principles

Three phase voltage and current are sampled from respective sampling circuit and transformed into suitable signal, which is carried into integrated circuit, then the meter output pulse signal in positive appropriation to measured power to drive step-motor counter or LCD counter to realize energy measurement. The meter has energy pulse output for testing with pulse width of 80+20ms

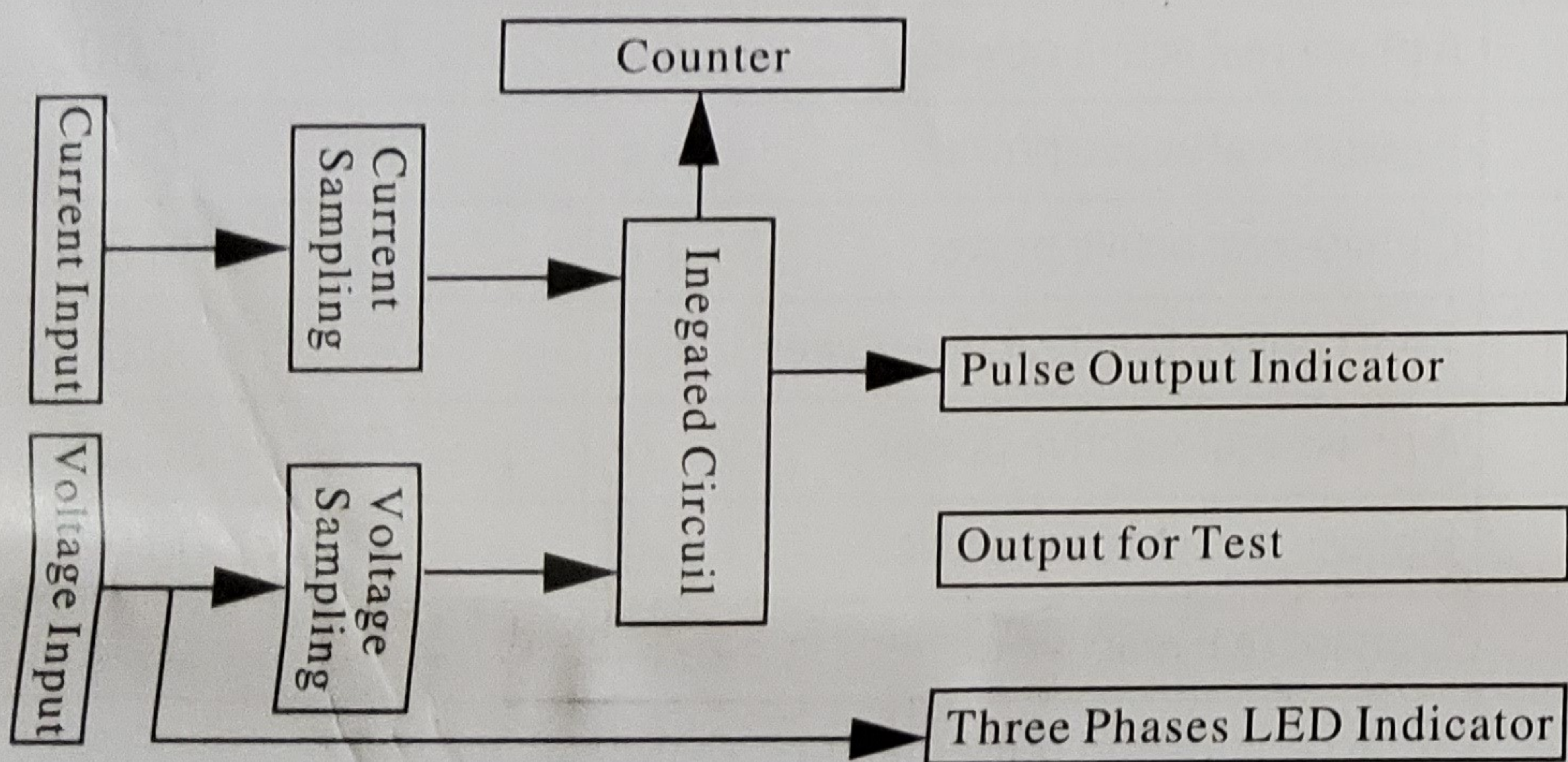

Diagram for Working Principles

5. Structure

The meter consists of meter base, meter cover, terminal base, terminal cover. there are lead seal on meter cover and terminal cover. A special screw is used to fix the terminal cover on which a lead seal can be installed

6. Usage

6.1 schematic diagram

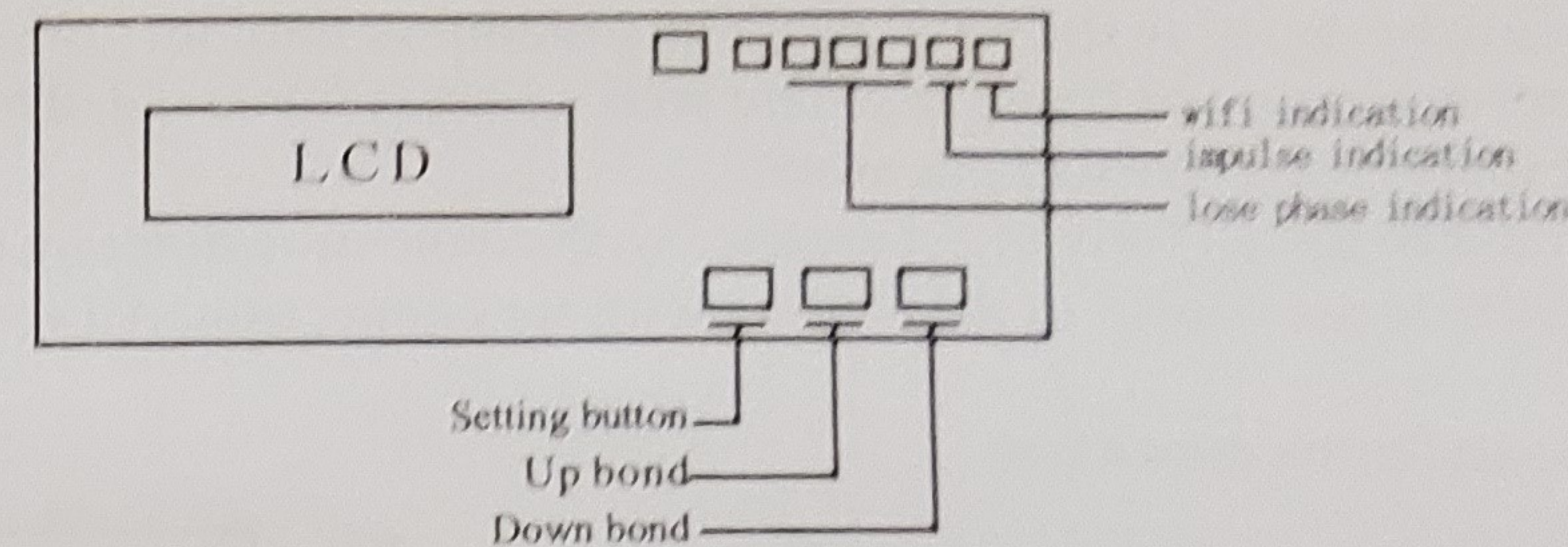

WiFi led indication, if you push the setting button last 10s, the WiFi led will flash 1s interval, its means meter enter into the status of waiting for WiFi distribution network. if WiFi led light on all time, it means meter connect the WiFi successfully.



Impulse led indication: it will flash with different speed according the current load of the meter

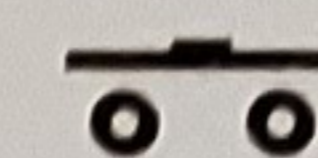

Relay off signal: the signal display on LCD means meter relay switch off.

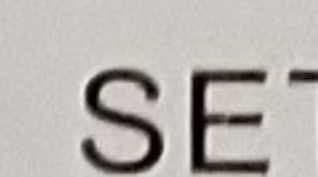

Setting button: you can push this button last 3s enter into change the MODBUS-RTU ID and baudrate of RS485 port.



Up bond: it used for display step by step and setting value under setting mode.



Down bond: it used for display step by step and setting value under setting mode. if you push this button last 10s, meter will enter into the the status of waiting fo wifi distribution network.

6.1 Connection diagram

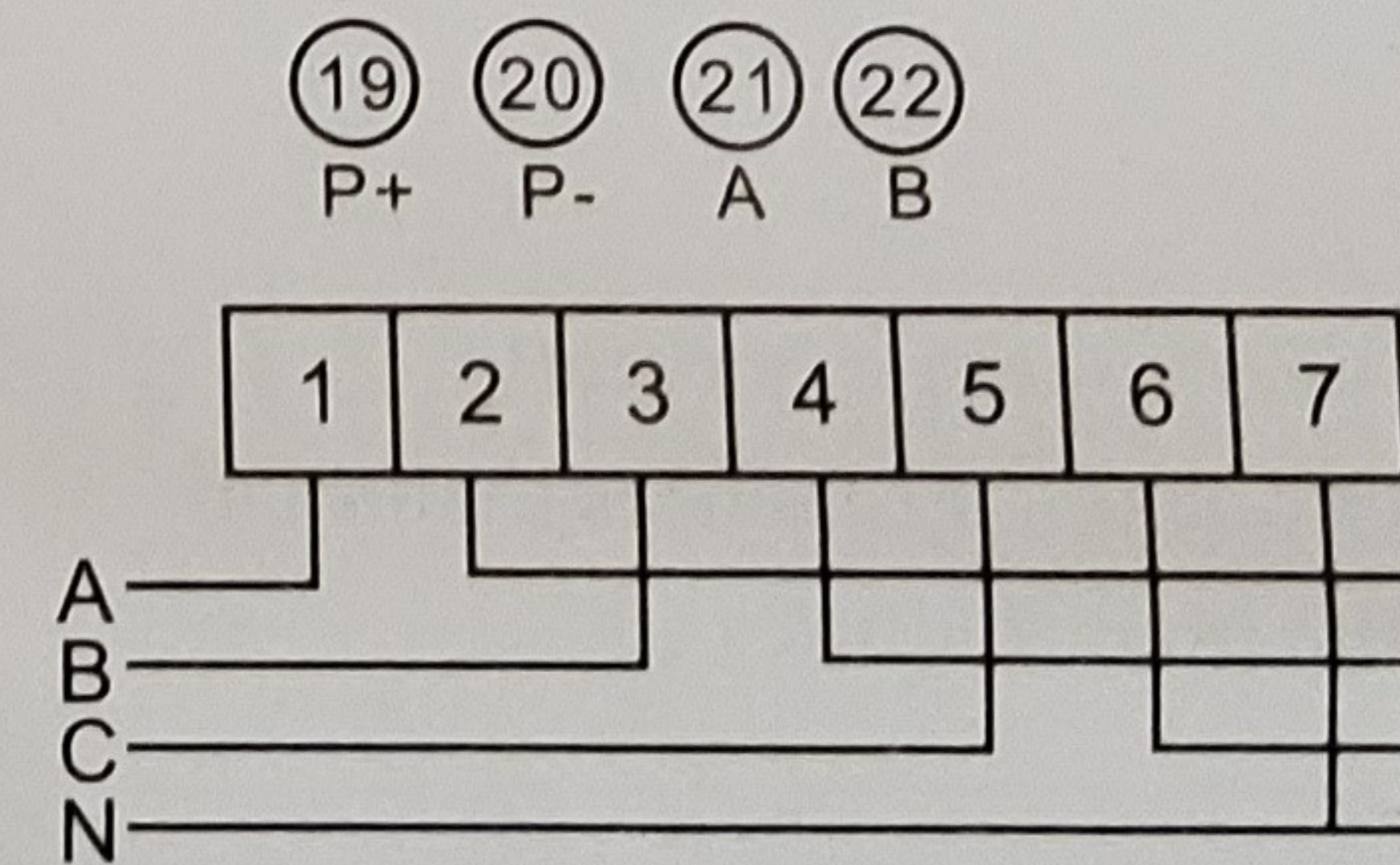

(current wire bottom in and bottom output)
Direct input type connection diagram

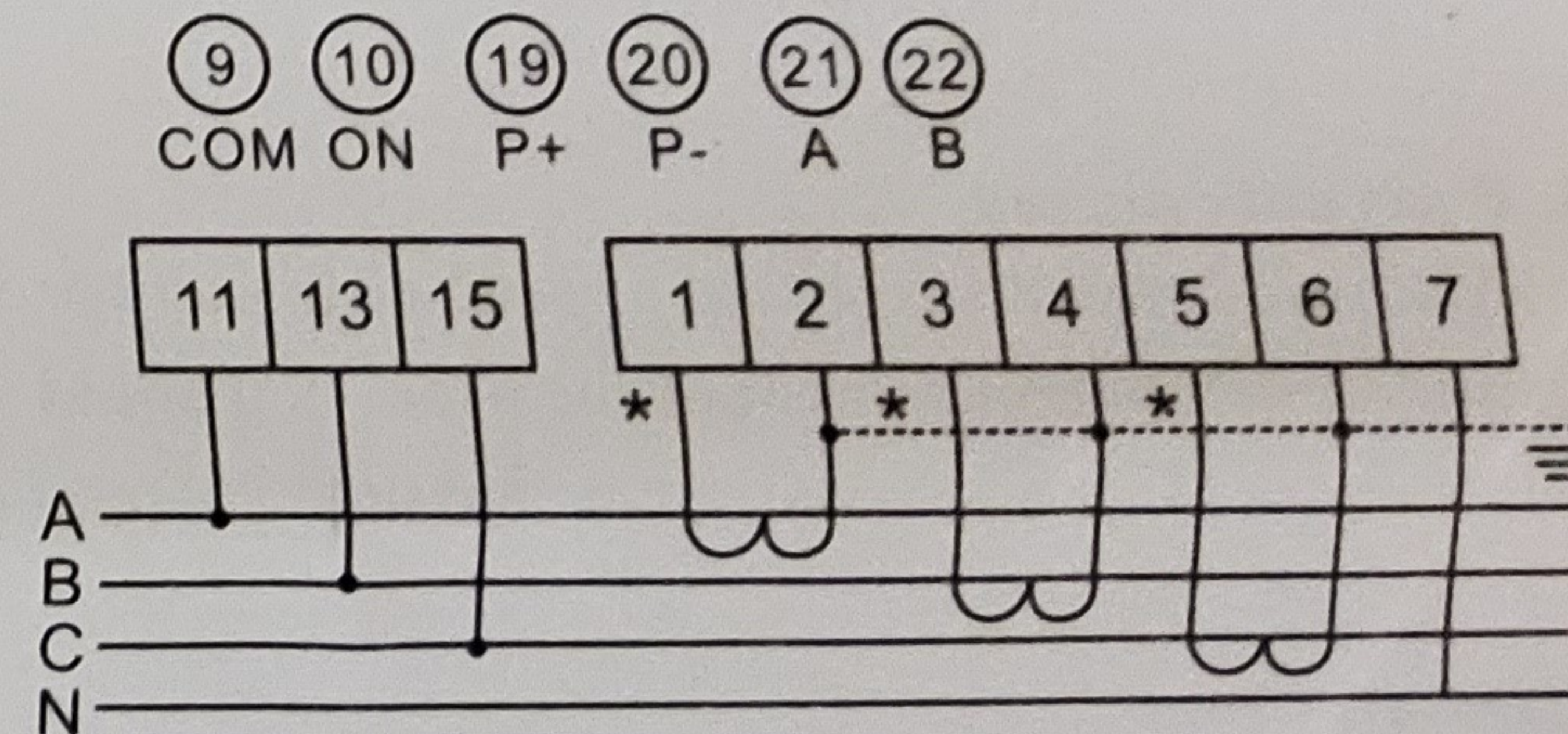

(current wire bottom in and bottom output)
Transformer input type connection diagram

Noting: for CT input type connection, the power consumed display in register is not fact power consumed. The fact power= the power display in register of meter X CT rate. For example, the power display in the register is 0.5 kWh and the CT is 800/5A, the fact power consumed=0.5 kWh X 160=80kWh

APP OPERATION INSTRUCTION

1. Please download the "SMART LIFE" software from google play or App store.



2. let your mobile phone to connect the house WIFI and open the APP software . follow the APP guide to register and login in the account to add the device. Make sure the device is power on , and push the setting button last 10s ,the WIFI led will flash quickly to let meter enter into the status of waiting for WIFI distribution network , then click confirm button

3. Add device as following

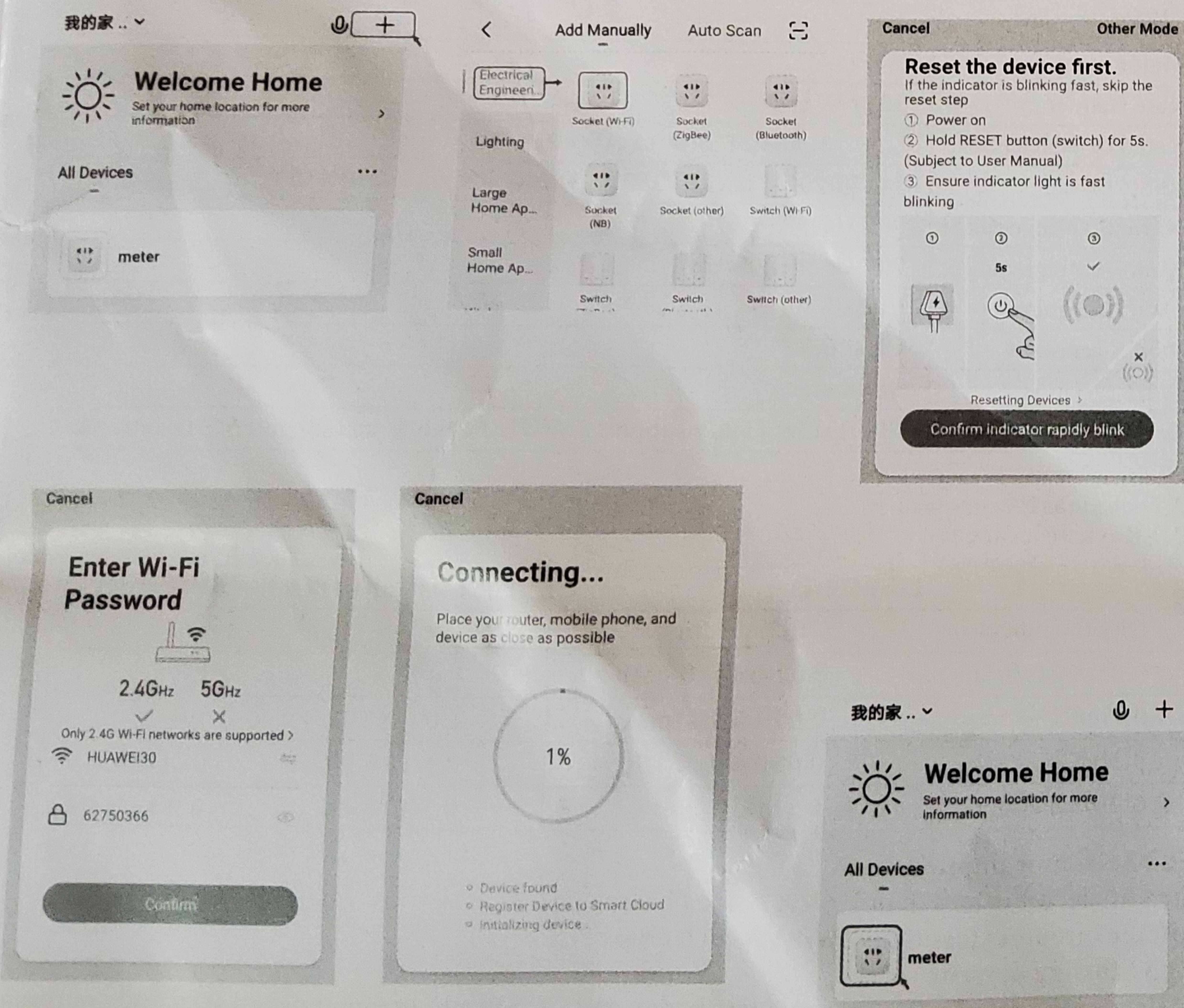

3.7

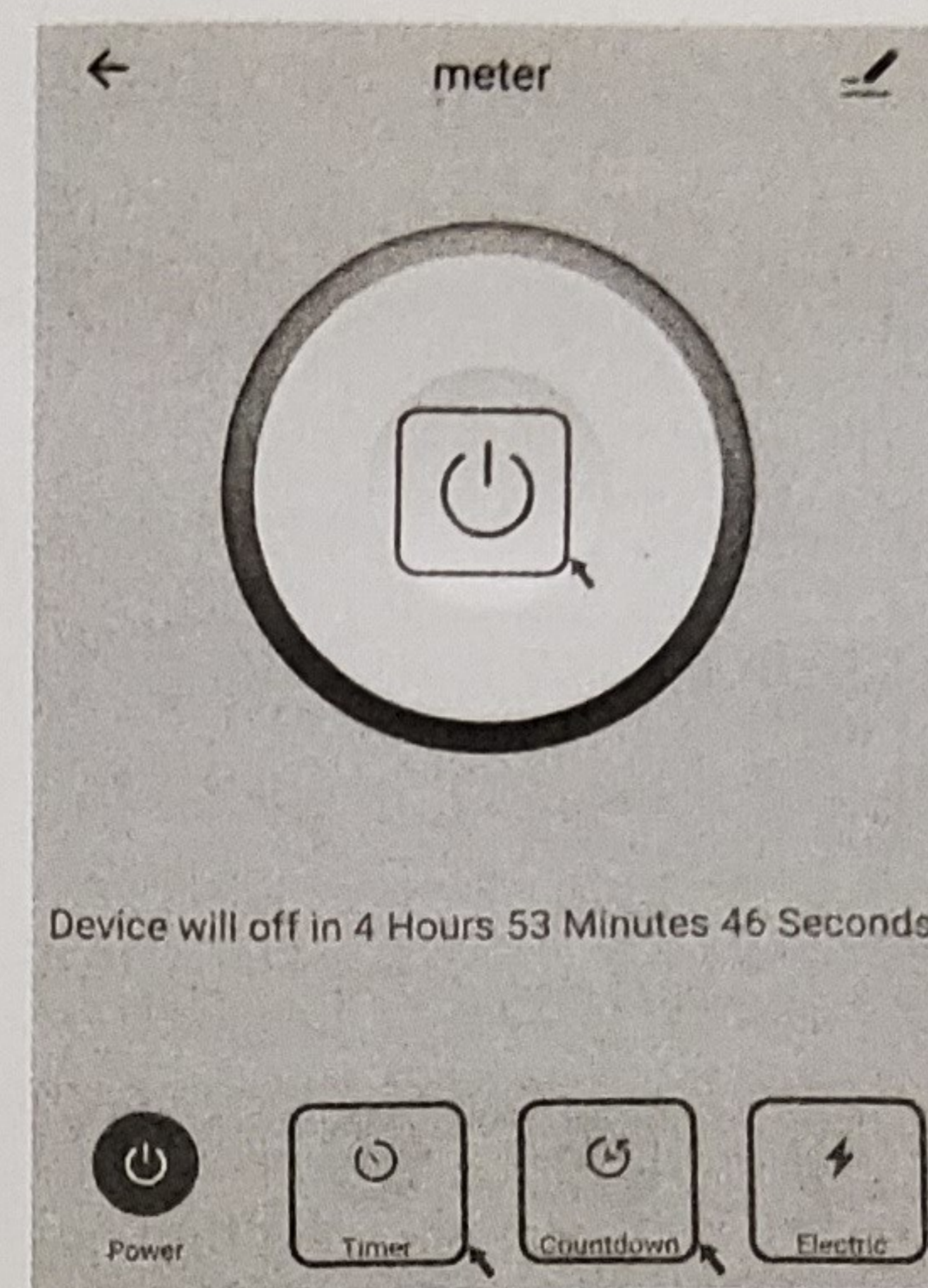

3.8

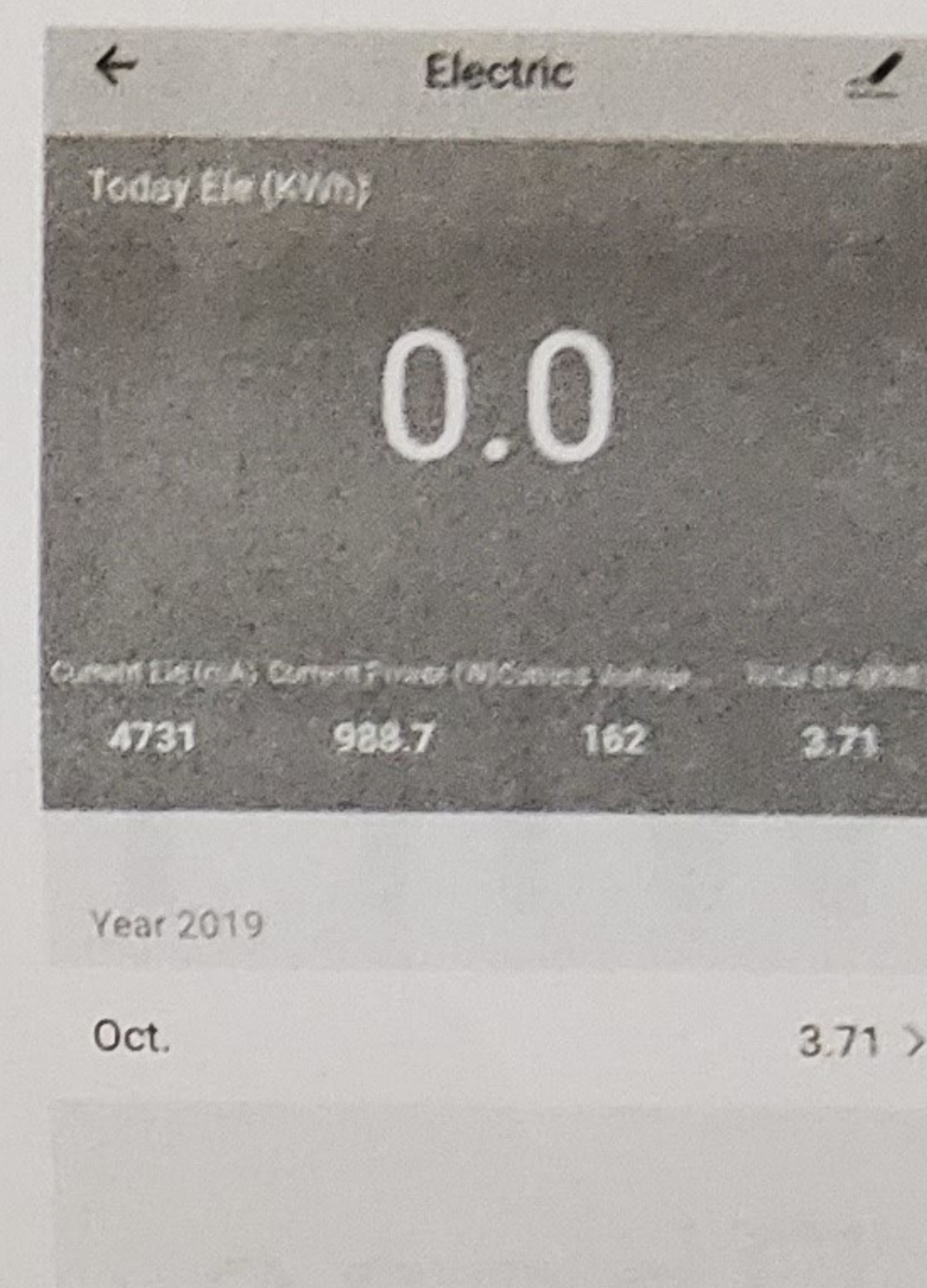

3.9

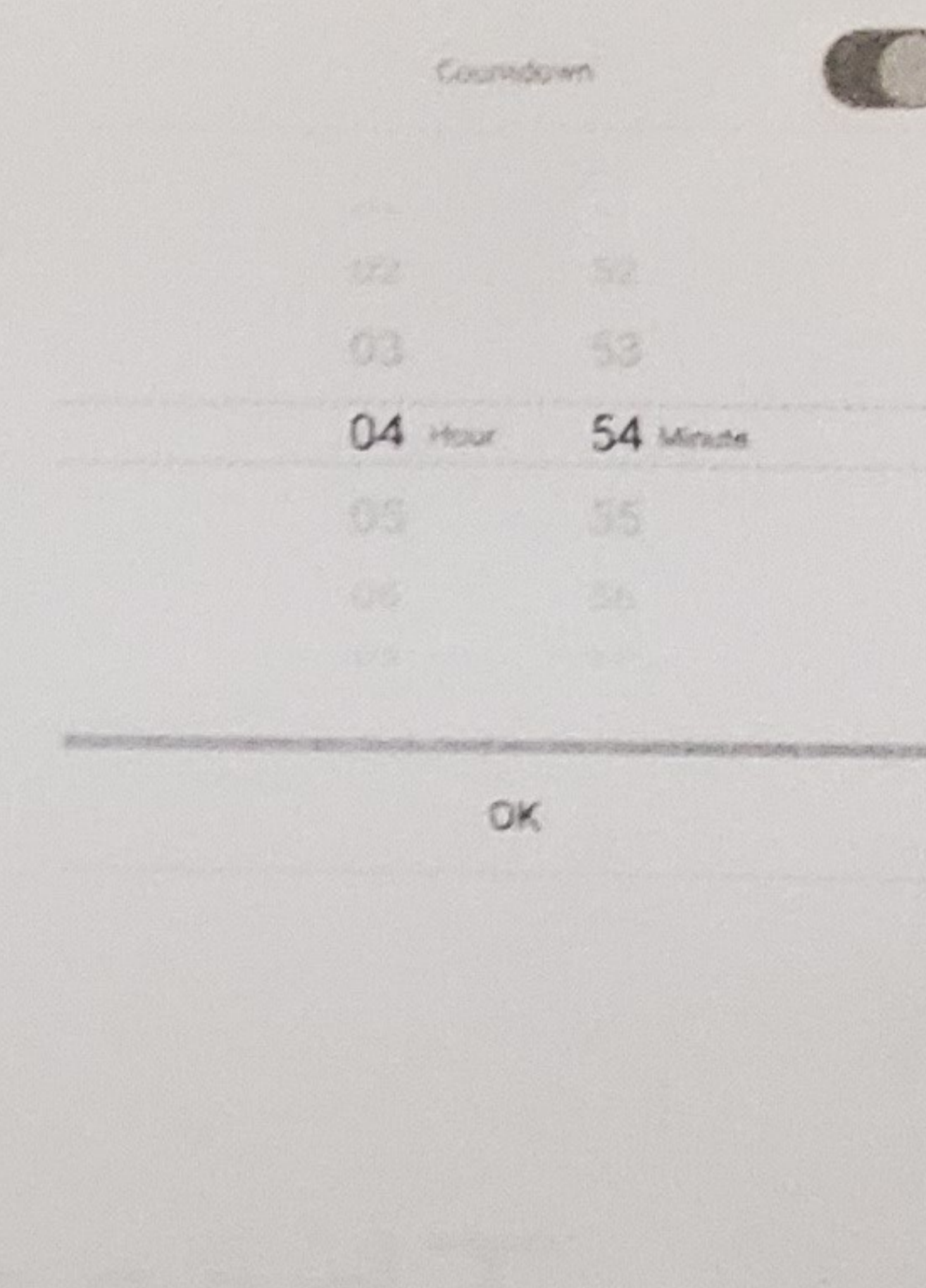

3.10

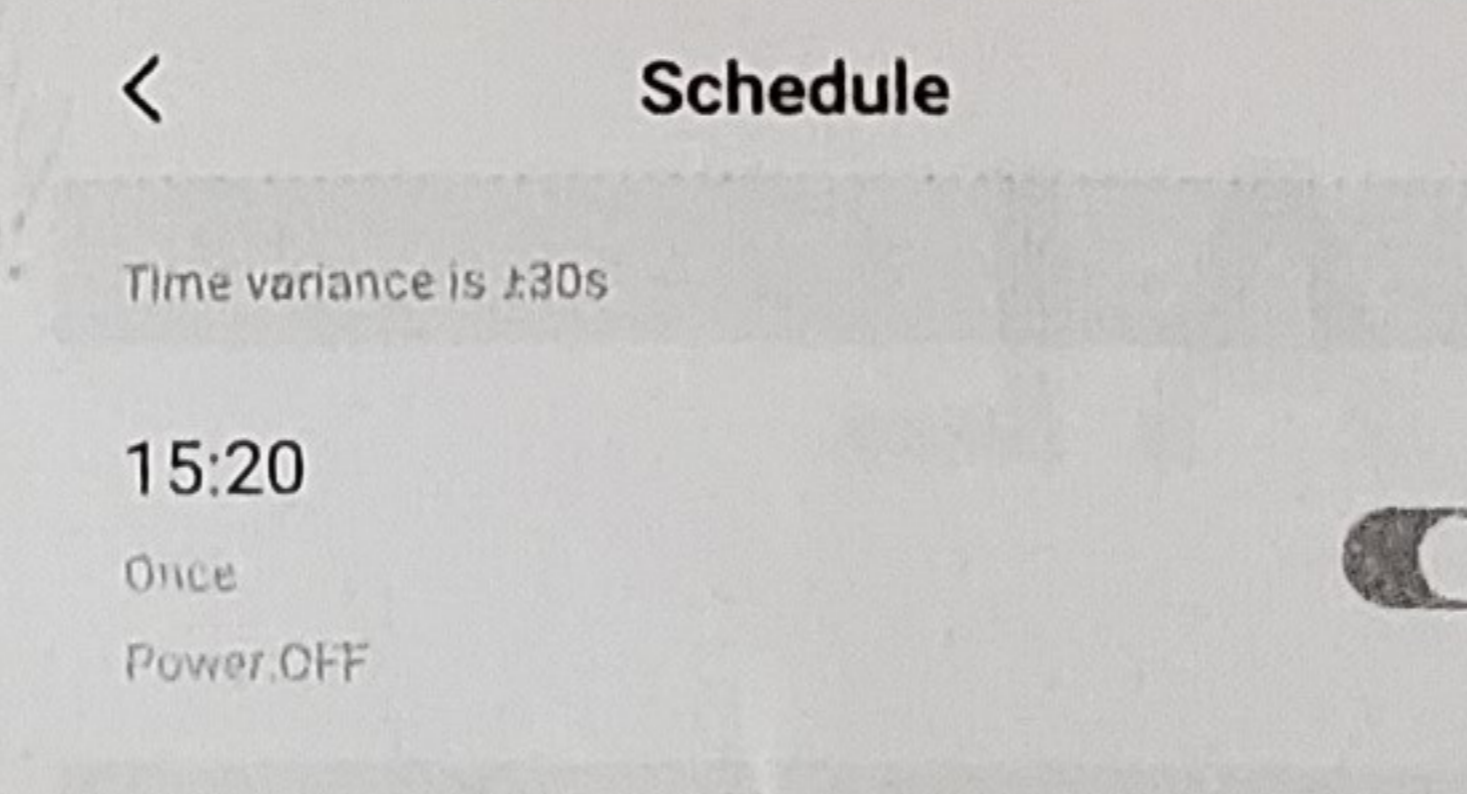

3.11

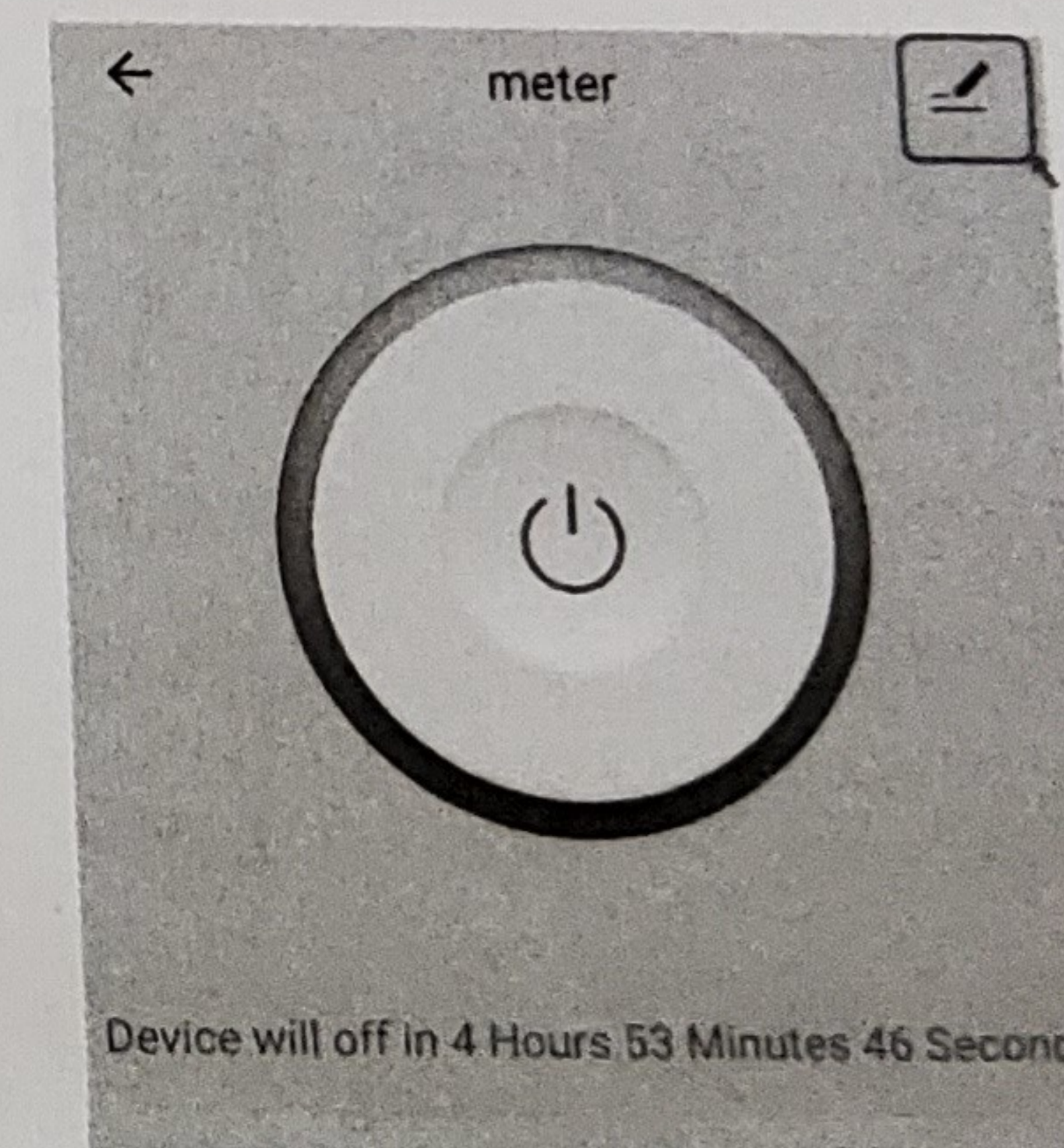

3.12

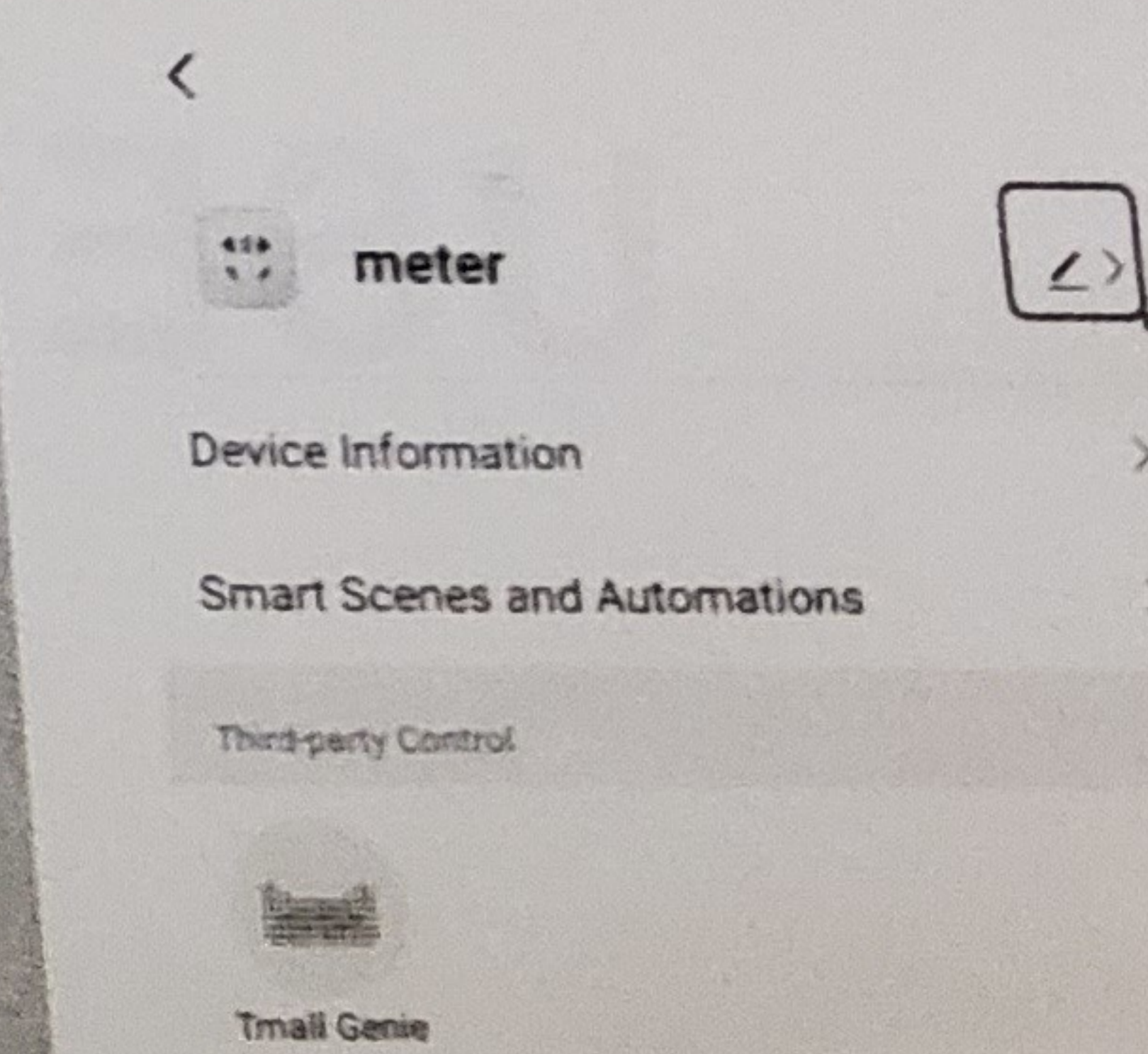

If equipment connect successfully , you can realize remote control on/off , timer control and delay time control , and read the energy and current /voltage/ active power and history energy data.

Note: WIFI meter is only support 2.4GHz network , not support 5GHz network
Note: the APP display R.M.S current and voltage is only A phase of three phase .
The APP display R.M.S active power is conjunction phase total active power

6.2 Installation

The meter can be installed on a 35 mm DIN rail

6.2.1 The meter can not be installed and used until it is checked goods and sealed before delivery

6.2.2 The meter should be installed in the water proof box indoor or outdoor, the meter's box should be fixed on strong and flame-resistant wall with a recommended height of about 1.8 m, where there is no corrosive gas around.

6.2.3 The meter should be installed fully in accordance with connection diagram on the terminal cover, it is better to use copper as the leading wire for connection. All screws should be tightened.

6.2.4 Diagram for installation dimension

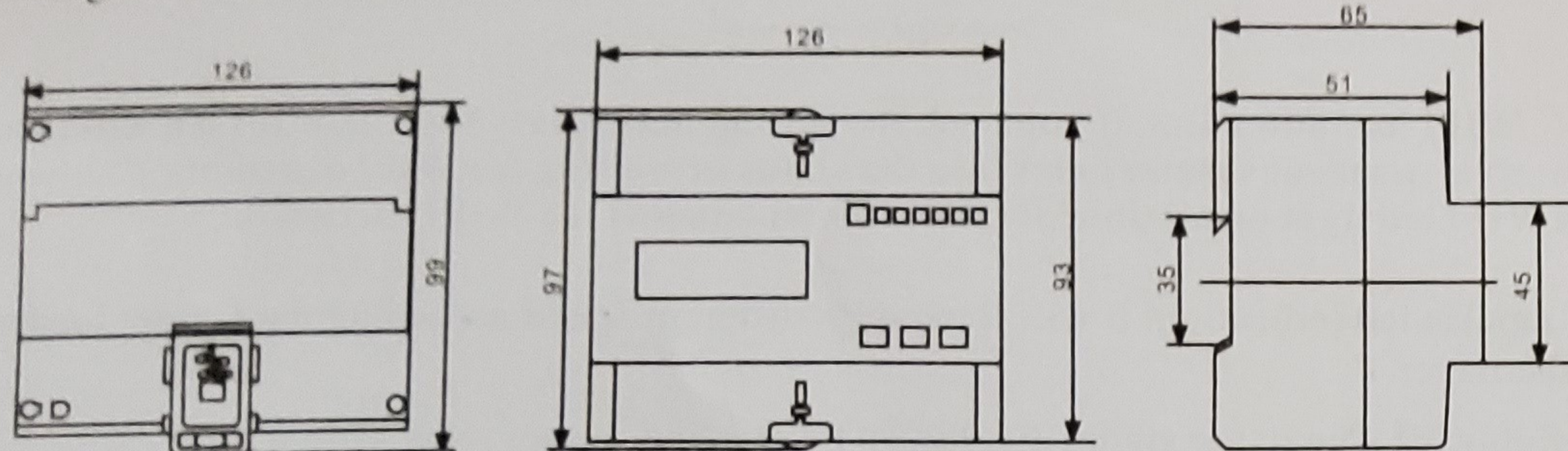

7. Transportation and Storage

7.1 Heavy impact should be burdened to the products while transportation and unpacking.

7.2 The products should be stored in the original package and kept in place with temperature between $-40^{\circ}\text{C} \sim +70^{\circ}\text{C}$, the relative humidity less than 75% and no corrosive gas around.

7.3 In storehouse, the meter should be placed on the shelf when kept in stock, there should not be more than 7 cartons piled up in vertical. Single-packed meters can not be piled up with more than 5 meters in vertical.

8. Warranty period

Within 12 months from the day of selling and provided that users operate correctly according to the requirement of the user's manual, if the meter doesn't reach its technical specification. It can be repaired or replaced in free of charge by the manufacturer.

Display item

Display item:

	Display Item	LCD display
01	RS485 baudrate	b 0000
02	Meter serial high 6 digit	H 000000
03	Meter serial low 6 digit	L 000000

04	RS485 ID		Id	000
05	Impulse constant	imp/kWh	C	0000
06	Total active energy	kWh	00	000000.00
07	Import active energy	kWh	01	000000.00
08	Export active energy	kWh	02	000000.00
09	Total reactive energy	kvarh	10	000000.00
10	Balance energy	kWh	E	000000.00
11	A phase real voltage	V	UR	000.0
12	B phase real voltage	V	Ub	000.0
13	C phase real voltage	V	UC	000.0
14	A phase real current	A	IR	000.000
15	B phase real current	A	Ib	000.000
16	C phase real current	A	IC	000.000
17	Total conjunction active power	kw	P	00.000
18	A phase real active power	kw	PR	00.000
19	B phase real active power	kw	Pb	00.000
20	C phase real active power	kw	PC	00.000
21	Total conjunction reactive power	kvar	q	00.000
22	A phase real reactive power	kvar	qR	00.000
23	B phase real reactive power	kvar	qb	00.000
24	C phase real reactive power	kvar	qc	00.000
25	Total conjunction power factor	COSΦ	PF	0.000
26	A phase real power factor	COSΦ	PFR	0.000
27	B phase real power factor	COSΦ	PFb	0.000
28	C phase real power factor	COSΦ	PFC	0.000
29	Frequency	Hz	F	00.00